



## Input Line Chokes for Optidrives Installation Guide IP20 & IP66

### Using Input Chokes

Input chokes help protect the Optidrive from spikes on the incoming power supply, as well as reducing input harmonic currents. It is recommended that an input choke is used under the following circumstances:

- On all 600 Volt Size 2 and 3 Optidrives
- On all applications where the incoming power supply uses a sliding busbar or brushgear type arrangement (e.g. commonly used on overhead cranes)
- On all installations where the supply impedance is low or the fault current very high
- On all installations where the incoming power supply is prone to spikes, dips notches or other disturbances

Typically, the input choke will provide a significant reduction in harmonic distortion on the incoming power supply, and reduce the overall current into the drive.

### Important Safety Information

This option is specifically designed to be used with the Optidrive variable speed drive product range and is intended for professional incorporation into complete equipment or systems. If installed incorrectly it may present a safety hazard. The Optidrive uses high voltages and currents, carries a high level of stored electrical energy, and is used to control mechanical plant that may cause injury. Close attention is required to system design and electrical installation to avoid hazards in either normal operation or in the event of equipment malfunction. Optidrives and the Options should be installed only by qualified electrical persons and in accordance with local and national regulations and codes of practice.

**Electric shock hazard!** Disconnect and **ISOLATE** the Optidrive before attempting any work on it. High voltages are present at the terminals and within the drive for up to 10 minutes after disconnection of the electrical supply.

Where the electrical supply to the drive is through a plug and socket connector, do not disconnect until 10 minutes have elapsed after turning off the supply. It is the responsibility of the installer to ensure that the equipment or system into which the product is incorporated complies with the EMC legislation of the country of use. Within the European Union, equipment into which this product is incorporated must comply with 2004/108/EC, Electromagnetic Compatibility. Within the European Union, all machinery in which this product is used must comply with the Directive 98/37/EC, Safety of Machinery. In particular, the equipment should comply with EN60204-1.

The manufacturer accepts no liability for any consequences resulting from inappropriate, negligent or incorrect installation.

The contents of this User Guide are believed to be correct at the time of printing. In the interests of a commitment to a policy of continuous improvement, the manufacturer reserves the right to change the specification of the product or its performance or the contents of the User Guide without notice.

### Dimensions – IP20 Single Phase

Part Number	Optidrive Size	Connection (mm <sup>2</sup> )	L (mm)	H (mm)	B (mm)	N1 (mm)	N2 (mm)	ØD (mm)	Rated Volts	Rated Amps	Inductance (mH)	Weight (kg)
OPT-2-L1016-20	1	4	78	80	78	56	49	4.8	230 Max	16	1.8	1.1
OPT-2-L1025-20	2	10	85	158	76	100	55	5		25	1.1	1.8

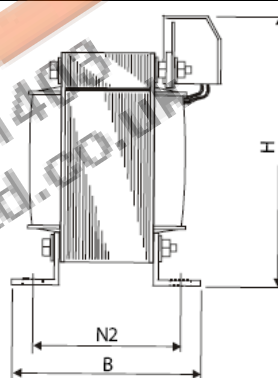
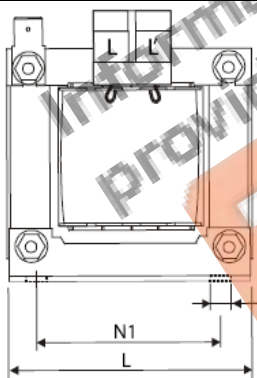

Part Number	Optidrive Size	Connection (mm <sup>2</sup> )	L (mm)	H (mm)	B (mm)	N1 (mm)	N2 (mm)	ØD (mm)	Rated Volts	Rated Amps	Inductance (mH)	Weight (kg)
OPT-2-L3006-20	1	2.5	95	107	56	56	43	4.8 x 9	500 Max	6	4.8	1.3
OPT-2-L3010-20	2	2.5	125	127	71	100	55	5 x 8		10	2.9	2.5
OPT-2-L3036-20	3	10	190	205	82	170	58	8 x 12		36	0.81	7.2
OPT-2-L3050-20	4	16	190	220	102	170	78	8 x 12		50	0.58	8.7
OPT-2-L3090-20	5	35	240	280	107	185	85	10 x 18		90	0.32	16

OPT-2-L3006-20, OPT-2-L3010-20

OPT-2-L3036-20, OPT-2-L3050-20, OPT-2-L3090-20

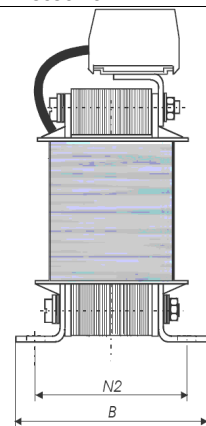
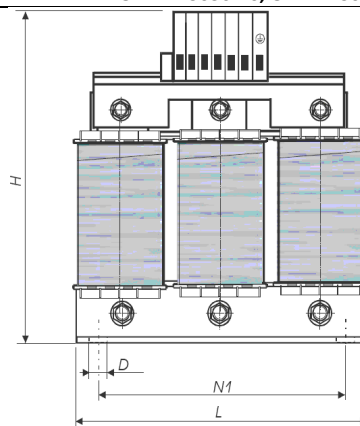
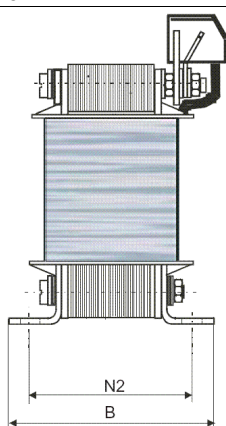
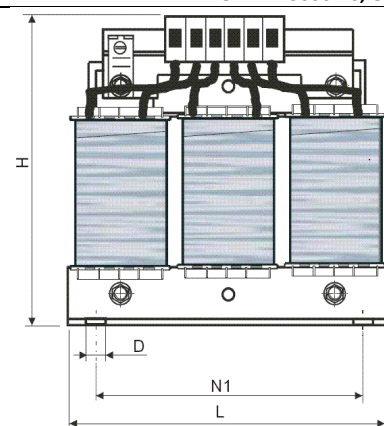

Part Number	Optidrive Size	Connection D2 (mm)	L (mm)	H (mm)	B (mm)	N1 (mm)	N2 (mm)	ØD (mm)	Rated Volts	Rated Amps	Inductance (µH)	Weight (kg)
OPT-2-L3200-00	6	9	310	260	180	224	117	10 x 18	500	200	73.5	35
OPT-2-L3300-00	7	9	370	310	180	248	139	10 x 18		300	49.0	48

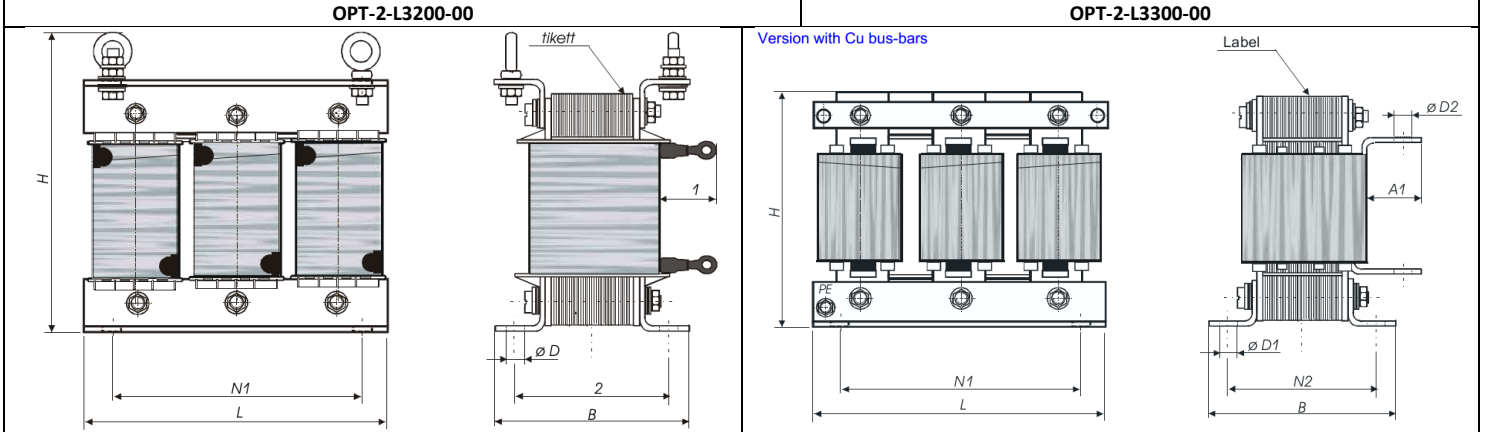

**Mounting Dimensions – IP66**

Part Number	Optidrive Size	Connection (mm <sup>2</sup> )	L (mm)	H (mm)	B (mm)	N1 (mm)	N2 (mm)	ØD (mm)	L1 (mm)	H1 (mm)	B1 (mm)	Rated Volts	Rated Amps	Inductance (mH)	Weight (kg)	
OPT-2-L1016-66	1	4	82	70	70	70	58	6	151	60	85	230	16	1.83	1.0	
OPT-2-L1025-66	2	10	90	75	84	84	72	6	151	60	85		Max	25	1.17	1.3
OPT-2-L3006-66	1	2.5	115	88	74	80	60	5.5 x 7	151	60	85	600	6	4.8	1.6	
OPT-2-L3010-66	2	2.5	175	137	99	130	79	5.5 x 12	151	60	85		Max	10	3.86	3.5
OPT-2-L3018-66	3	10	175	137	114	130	94	5.5 x 12	151	60	85		Max	18	2.04	7

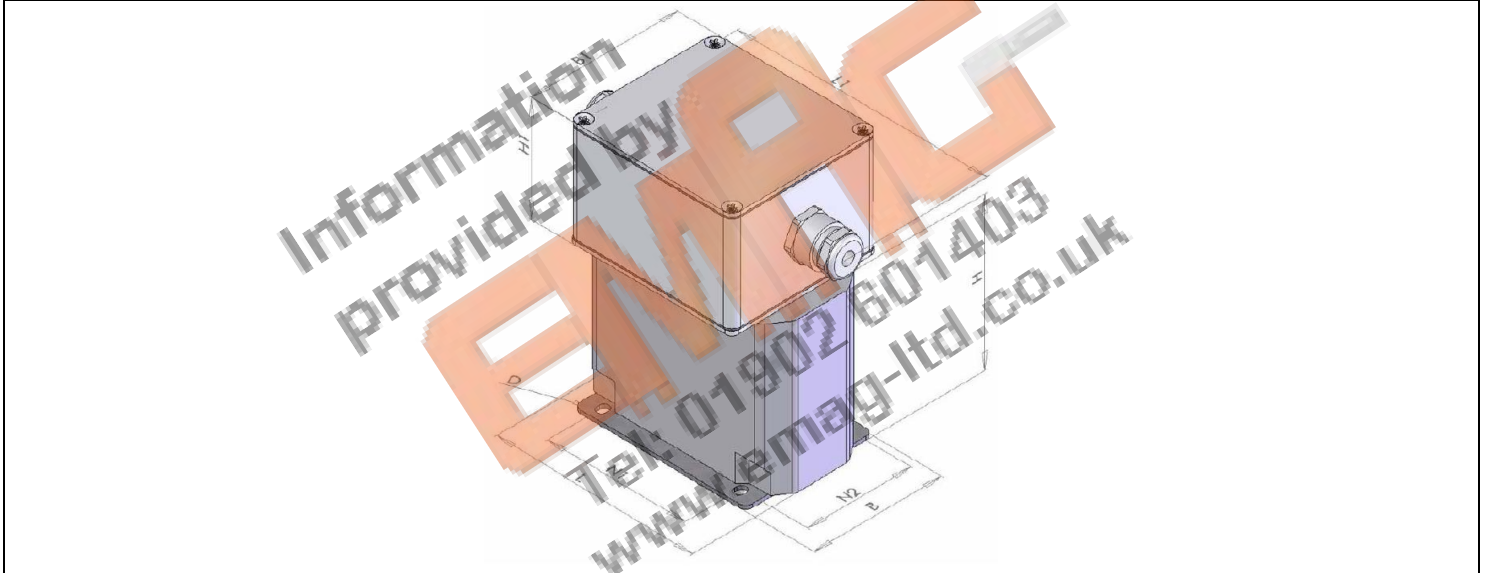

**Installation Schematic Diagram**

